

# BAZOONGI Kids™

## JUMPPOD

7.5ft Trampoline Tent

### USER MANUAL

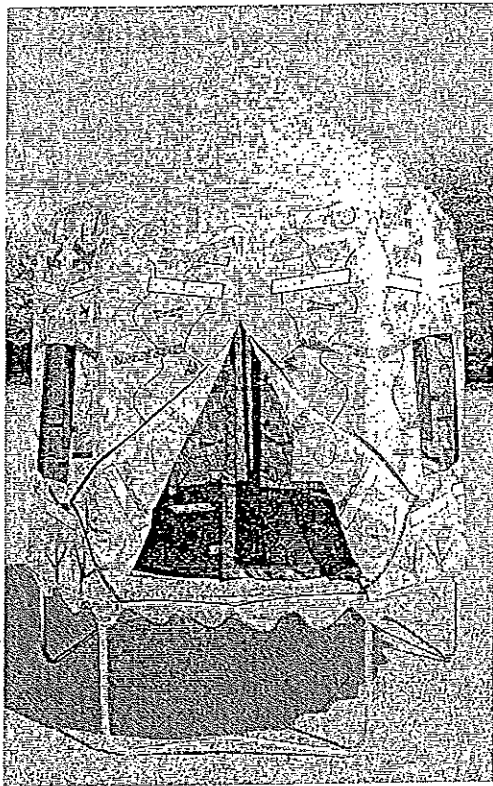

**Treehouse**

Style#19101

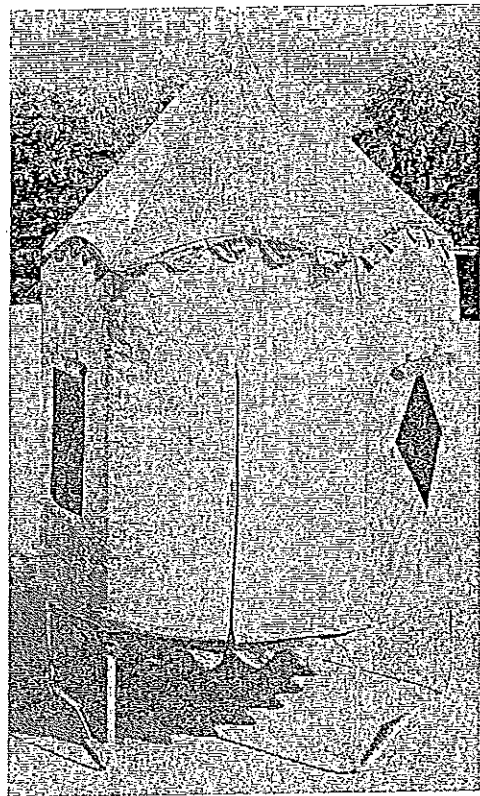

**Circus**

Style#19102

# BAZOONGI Kids JUMPPOD™

## CAUTION

- Recommended for children over 3 years.
- Adult assembly required.
- NEVER let children fold or unfold this product.
- Warning! Keep away from fire.
- Clean only with a damp cloth.
- Recommended for outdoor use.
- Only use this product on a cleared area, free of any toys or sharp objects.
- Not waterproof or made for camping.
- NEVER shelter in this product during a thunderstorm.
- Do not continue to use this product if any part of the frame becomes either bent or broken.
- Constant adult supervision is recommended.
- 7.5ft Trampoline Style#19100 sold separate
- The tent is designed only for use on Bazoongi 7.5ft Jump Pod trampoline. Tent NOT designed for single use without 7.5ft Jump Pod.

Meets CPAI-84 specifications, but is NOT FIRE PROOF.

WARNING KEEP ALL FLAME AND HEAT SOURCES AWAY FROM THIS TENT FABRIC. This fabric may burn when left in continuous contact with any heat source.

# Assembly

## Step 1

Unfold the G3 fiber glass pole. Repeat this step to assemble five more G3 fiber glass pole sections.

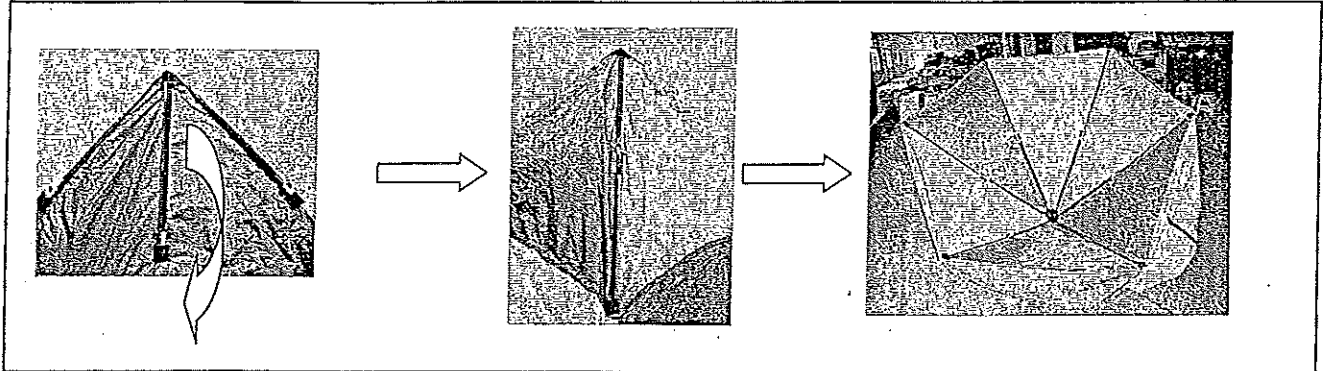

## Step 2

Attach the tent to the top of 7.5ft Jump Pod as picture show.

**IMPORTANT:** Make sure while pulling the tent over the enclosure frame the DOORS of the tent are in the same positions as the DOORS of the enclosure net. If this step is done incorrectly it will be difficult to move the doors into place when the tent is assembled around the frame.

Note: It is recommend that this step be completed by two persons.

One person (1) should stand on the jumping surface of the trampoline while the other person (2) stand outside near the frame of the trampoline. Person 1 should help guide the 6 G3 pole to align in the same positions as the 6 enclosure frame poles.

Once the poles are aligned in the proper place with the frame, person 2 should help pull the sides of the tent down around the frame of the enclosure. Person 2 may need to remain on the trampoline to help stabilize the tent while it is being assembled over the enclosure frame.

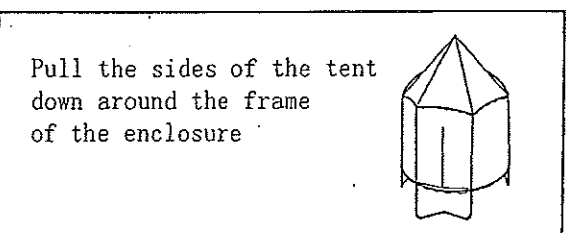
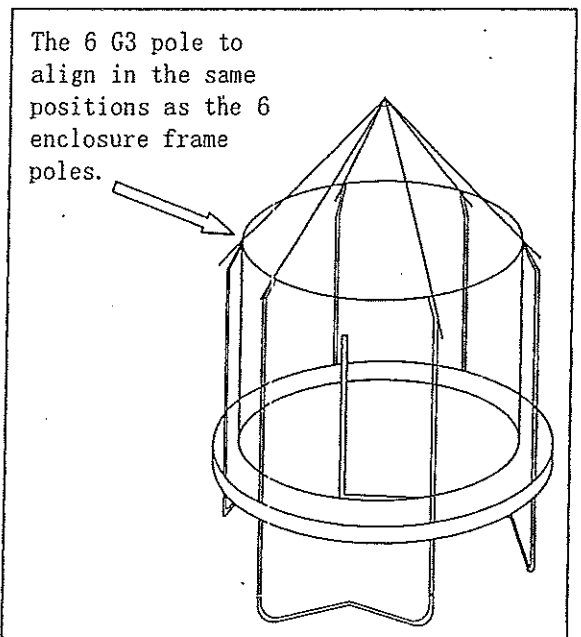
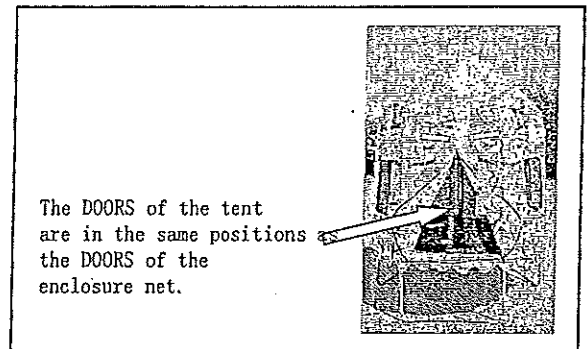

Step 3

Cross the strap with "S" hook over the toprail frame to hook the V-ring. See the insert drawing. Repeat this step with the remaining straps.

Cross the strap with "S" hook over the toprail frame to hook the V-ring.

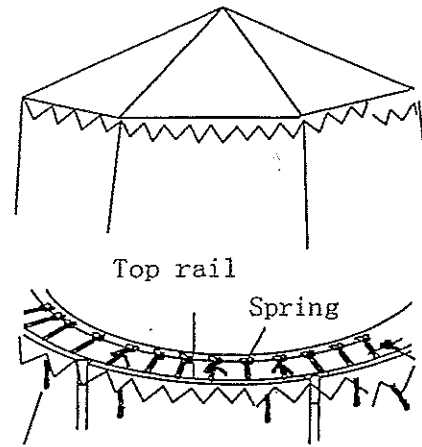
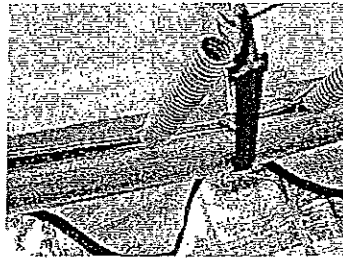

Strap with "S" hook on bottom of tent.

Step 4

The Trampoline tent is now fully assembled. Make sure that all parts are securely attached.

